

BY1T-1

1T单轮2钩牵引器

Breaking strength:1T

Cable: Φ 4.2mmX1.8M

Package(cm):56x21x24

Single gear,Single Line,Double hook

6PCS/CTN,G.W/N.W:15KG/13KG



BY1T-2

1T双轮2钩牵引器

Breaking strength:1T

Cable: Φ 4.2mmX1.8M

Package(cm):56x21x24

Single gear,Single Line,Double hook

6PCS/CTN,G.W/N.W:15KG/13KG



BY1TC-1

1T双轮彩带牵引器

Breaking strength:1T

Webbing:25mmX2M

Package(cm):56x21x24

Single gear,Single Line,Double hook

6PCS/CTN,G.W/N.W:15KG/13KG



VENIT

CARGO CONTROL SOLUTIONS

WWW.QDVENIT.COM • SALES@QDVENIT.COM

BY2T-1

2T单轮2钩牵引器

Breaking strength:2T

Cable: Φ 4.5mmX2.2M

Package(cm):61x26x22

Single gear,Single Line,Double hook

6PCS/CTN,G.W/N.W:17KG/15KG

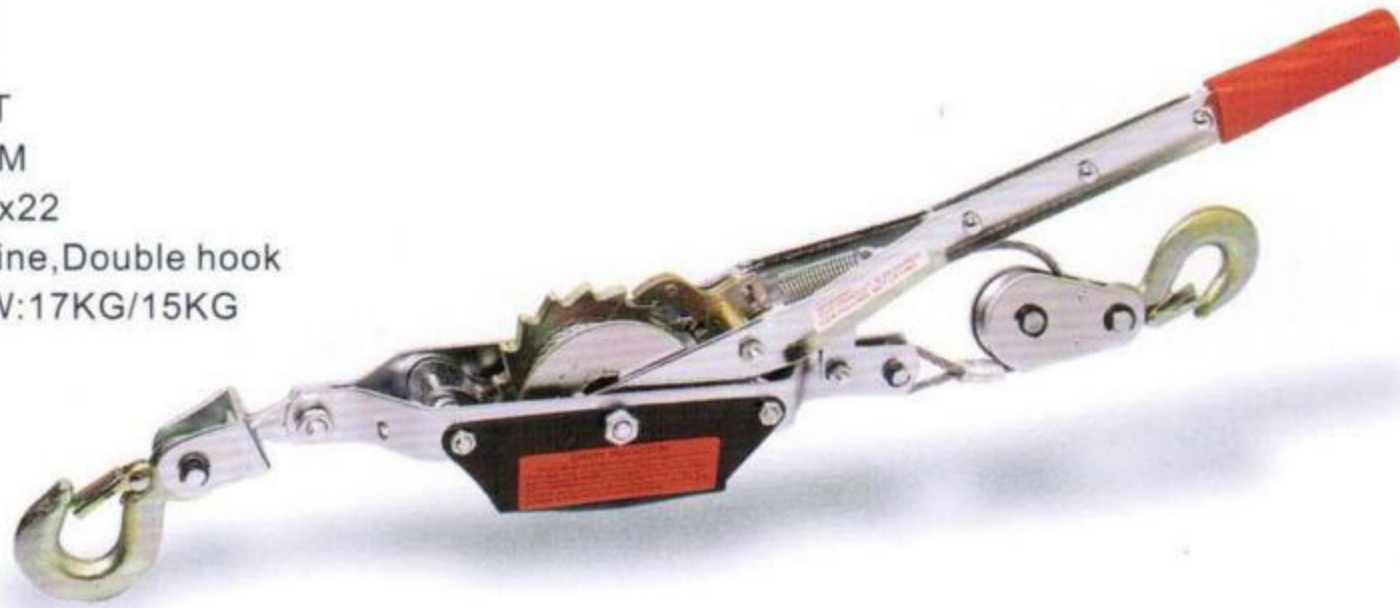

BY2T-2

2T双轮2钩牵引器

Breaking strength:2T

Cable: Φ 4.5mmX2.2M

Package(cm):61x26x22

Single gear,Single Line,Double hook

6PCS/CTN,G.W/N.W:17KG/15KG



BY2TC-1

2T双轮彩带牵引器

Breaking strength:2T

Webbing:36mmX3M

Package(cm):71x21x29

Single gear,Single Line,Double hook

4PCS/CTN,G.W/N.W:22KG/20KG



BY2TA-1

2TA型单轮2钩牵引器

Breaking strength:2T

Cable: Φ 4.8mmX3M

Package(cm):61x26x22

Single gear,Single Line,Double hook

6PCS/CTN,G.W/N.W:20KG/18KG



BY2TA-2

2TA型双轮2钩牵引器

Breaking strength:2T

Cable: Φ 4.8mmX3M

Package(cm):61x26x22

Single gear,Single Line,Double hook

6PCS/CTN,G.W/N.W:20KG/18KG



BY2TA-3

2TA型双轮3钩牵引器

Breaking strength:2T

Cable: Φ 4.8mmX3M

Package(cm):61x26x22

Single gear,Single Line,Triple hook

6PCS/CTN,G.W/N.W:22KG/20KG



BY3T-2

3T双轮轮2钩牵引器

Breaking strength:3T

Cable: Φ 5mmX3M

Package(cm):61x26x22

Single gear,Single Line,Double hook

6PCS/CTN,G.W/N.W:24KG/22KG



BY4T-1

4T单轮轮2钩牵引器

Breaking strength:4T

Cable: Φ 5.5mmX3M

Package(cm):71x21x29

Single gear,Single Line,Double hook

4PCS/CTN,G.W/N.W:22KG/20KG



BY4T-2

4T双轮轮2钩牵引器

Breaking strength:4T

Cable: Φ 5.5mmX3M

Package(cm):71x21x29

Single gear,Single Line,Double hook

4PCS/CTN,G.W/N.W:22KG/20KG



BY4TA-4

4TA型双轮3钩牵引器

Breaking strength:4T

Cable: Φ 6mmX3M

Package(cm):74x23x29

Single gear,Single Line, Triple hook

6PCS/CTN,G.W/N.W:25KG/23KG



JP2T

2T (1.5T) 日式拉紧器

参数:额定拉力2T (1.5T)

Parameter:rated pull 1.5T

钢丝规格: Φ 6X2.2m

Cable size: Φ 6X2.2m



钩子



G1



G2



G3



G4



G5



G6



G7

VENIT

CARGO CONTROL SOLUTIONS

WWW.QDVENIT.COM • SALES@QDVENIT.COM



1000LB彩带



1600LB彩带



2500LB彩带

手摇绞车彩带系列 BOAT WINCH W WEBBING SERIES

名称 Description	型号 Model	额定拉力(KG) Rated Pull LBS	齿轮比 Gear Ratio	手柄长度(mm) Handle Length	直轴轮径(mm) Drum-Hub Dia	彩带规格 Size of Colored Webbing	净重Net(kg) 毛重Gross (kg)	每箱台数 Pieces in Each Box	包装尺寸 Size of Package(cm)
手摇绞车 Winch	BY06	600 (270)	3.1:1	175	16	35x6m	13.5\11.5	6	59x26x16
	BY08	600 (360)	3.1:1	200	16	35x6m	15\13	6	59x26x16
	BY10	1000 (450)	4.1:1	200	18	50x8m	18.5\16.5	6	66x27x18
	BY12	1200 (540)	4.1:1	225	18	50x8m	19\17	6	66x27x18
	BY14	1400 (630)	4.1:1	225	18	50x8m	18.5\17.5	6	67x27x19
	BY16	1600 (720)	4.3:1	225	21	50x8m	16\14	4	46x31x20
	BY18	1800 (810)	4.1:1&9.8:1	250	21	50x8m	19\17	4	52x31x20
	BY20	2000 (900)	4.1:1&9.8:1	250	21	50x8m	20\18	4	52x31x20
	BY25	2500 (1100)	5.1:1&12.2:1	250	21	50x8m	22.5\20.5	4	54x31x22
	BY30	3000 (1350)	5.1:1&12.2:1	275	21	50x8m	22.5\20.5	4	54x31x22



600LB钢绳



1200LB钢绳



2500LB钢绳

手摇绞车钢丝绳系列 BOATWINCH W CABLE SERIES

名称 Description	型号 Model	额定拉力(KG) Rated Pull LBS	齿轮比 Gear Ratio	手柄长度(mm) Handle Length	直轴轮径(mm) Drum-Hub Dia	钢丝绳规格 Cable Size		净重Net(kg) 毛重Gross (kg)	每箱台数 Pieces in Each Box	包装尺寸 Size of Package(cm)
						直径 (mm) Diameter	长度 (m) Length			
手摇绞车 Winch	BY06	600 (270)	3.1:1	175	16	4.0	8	15\13	6	59x26x16
	BY08	600 (360)	3.1:1	200	16	4.0	8	17\15	6	59x26x16
	BY10	1000 (450)	4.1:1	200	18	4.2	10	20.5\18.5	6	66x27x18
	BY12	1200 (540)	4.1:1	225	18	4.2	10	21\20	6	66x27x18
	BY14	1400 (630)	4.1:1	225	18	4.5	10	21.5\19.5	6	67x27x19
	BY16	1600 (720)	4.3:1	225	21	4.5	10	18.5\16.5	4	46x31x20
	BY18	1800 (810)	4.1:1&9.8:1	250	21	4.5	10	21.5\19.5	4	52x31x20
	BY20	2000 (900)	4.1:1&9.8:1	250	21	4.5	10	22.5\20.5	4	52x31x20
	BY25	2500 (1100)	5.1:1&12.2:1	250	21	4.8	10	23.5\21.5	4	54x31x22
	BY30	3000 (1350)	5.1:1&12.2:1	275	21	5	10	25\23	4	54x31x22



涡轮绞车

TURBO-ROD WINCHES SERIES



2000LB涡轮

参数:额定拉力900KG, 齿轮比41:1,
齿轮模数:3mm, 轮轴直径:38mm

PARAMETER:pulling force load 900KGs,
Gear Ratio:41:1,Drum-Hub Dia:3mm,
Drum-Hub Dia:38mm.

VENIT

— CARGO CONTROL SOLUTIONS —

WWW.QDVENIT.COM • SALES@QDVENIT.COM



600LB空架绞车



1600LB空架绞车



2500LB空架绞车

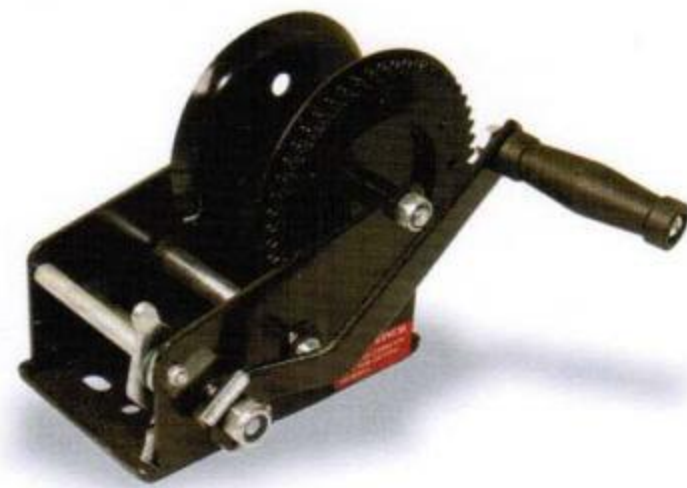

2000LB喷塑绞车

手摇绞车系列 BOAT WINCH W\CABLE SERIES

名称 Description	型号 Model	额定拉力(KG) Rated Pull LBS	齿轮比 Gear Ratio	手柄长度(mm) Handle Length	轮轴直径(mm) Drum-Hub Dia	净重Net(kg) 毛重Gross	每箱台数 Pieces in Box	包装尺寸 Size of Package(cm)
手 摇 绞 车 Winch	BY06	600 (270)	3.1:1	175	16	13\11	6	59x26x16
	BY08	600 (360)	3.1:1	200	16	14.5\12.5	6	59x26x16
	BY10	1000 (450)	4.1:1	200	18	18\16	6	66X27X18
	BY12	1200 (540)	4.1:1	225	18	18.5\16.5	6	66x27x18
	BY14	1400 (630)	4.1:1	225	18	19\17	6	67x27x19
	BY16	1600 (720)	4.3:1	225	21	15\13	4	46x31x20
	BY18	1800 (810)	4.1:1&9.8:1	250	21	18\16	4	52x31x20
	BY20	2000 (900)	4.1:1&9.8:1	250	21	19\17	4	52x31x20
	BY25	2500 (1100)	5.1:1&12.2:1	250	21	21\18	4	54x31x22
	BY30	3000 (1350)	5.1:1&12.2:1	275	21	22\20	4	54x31x22



自锁系列

BOAT WINCH ACCESSORY SERIES



自刹式绞车系列 BOAT WINCH ACCESSORY SERIES

Model	1200LBS	1800LBS	2600LBS	
Safe Working Load LBS	1200	1800	2600	
Test Load KN	8	12.13	17.64	
Gear Ratio	4.2:1	5:1	10:1	
Dimensions (mm)	A	156	203	216
	B	184	256	293
	C	88	107	127
	D	210	319	319
	E	27	27	27
	F	272	283	305
	G	51	60	63
	H	109	109	109
Volume cm	3.7	7.7	10.1	
Net weight Kg	16X16X22	35X20X23	35X24X24	

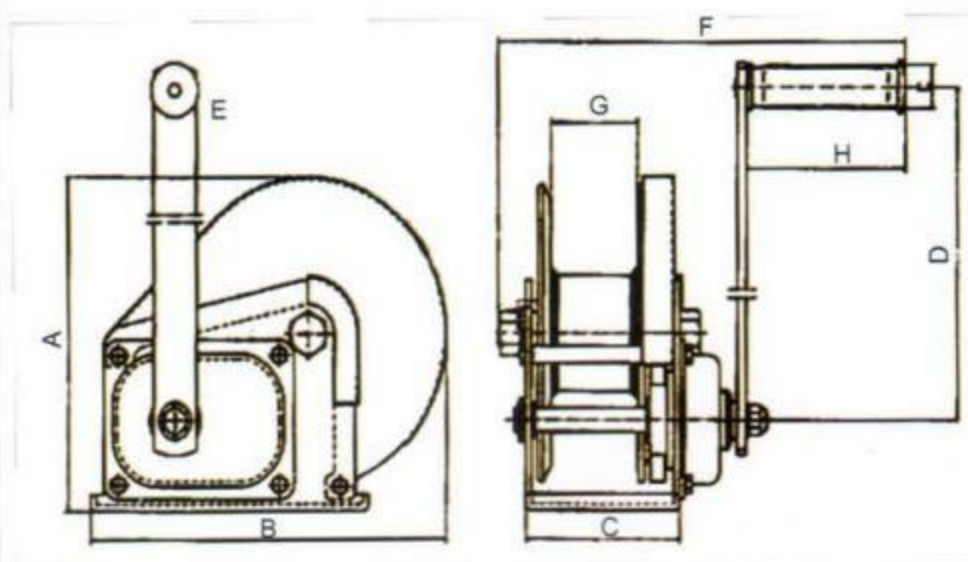

VENIT

— CARGO CONTROL SOLUTIONS —

WWW.QDVENIT.COM • SALES@QDVENIT.COM



1200LB自锁

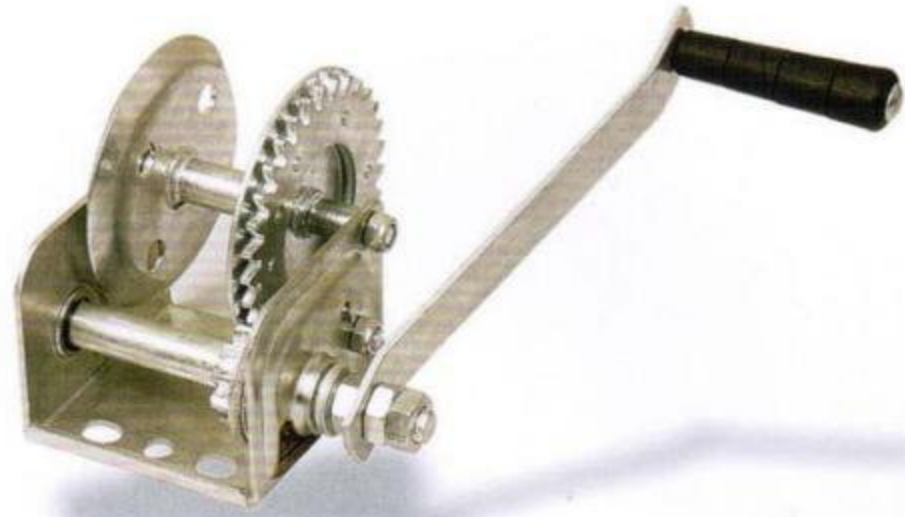

600LB自锁



1800LB自锁

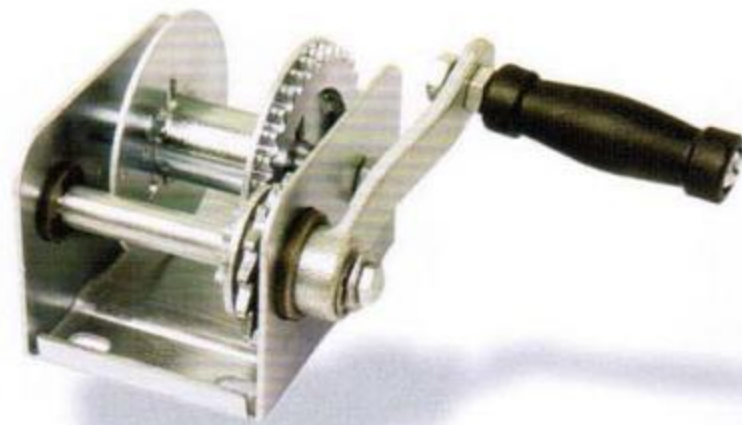

800LB自锁

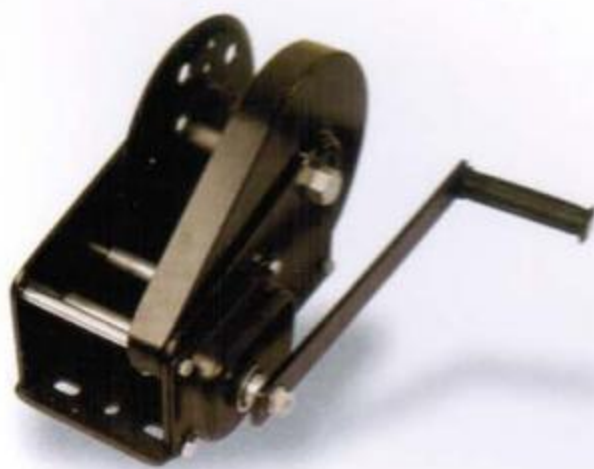

2500LB自锁

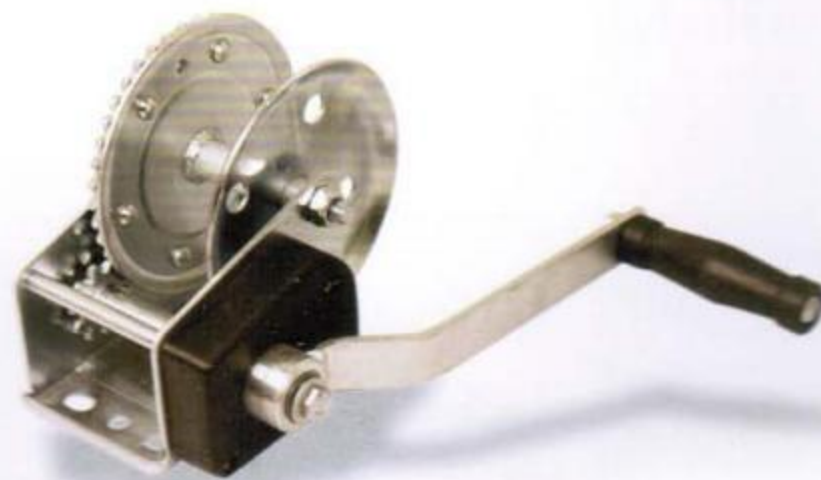

1200LB自锁

VENIT

CARGO CONTROL SOLUTIONS

WWW.QDVENIT.COM • SALES@QDVENIT.COM

BY-01

Ratchet tie down
25mm*5m
LC:300dan



BY-02

Ratchet tie down
25mm*5m
LC:125dan



电车绞盘-1

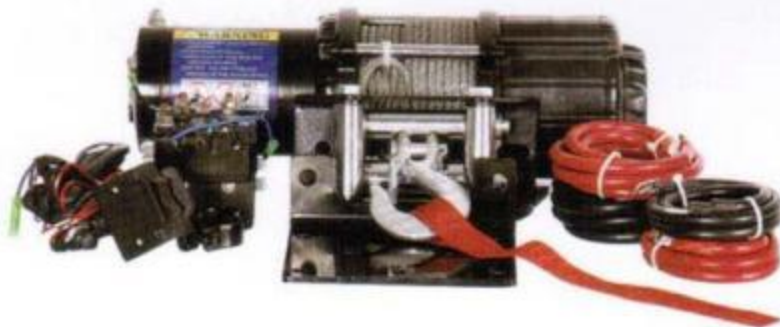

电车绞盘-2



夹线器-1

Safe load:1.5.ton
Cable size:4-22m/m
W.T:1.5kg



夹线器-2

Safe load:2.ton
Cable size:4-22m/m
W.T:1.5kg



BY-03

BY2000LB

PARAMETER:Rated pull 2000LB(900kg)
Size of nylon wire:Diameter Φ 8mm,Length 20m
Puller block no 3,Net/Gross 18/20kg



BY-04

BY800LB

PARAMETER:Rated pull 800LB (360kg)
Size of nylon wire:Diameter Φ 6mm,Length 20m
Puller block no 4,Net/Gross 23/25kg



BY-05

BY500LB

PARAMETER:Rated pull 500LB (200kg)
Size of nylon wire:Diameter Φ 5mm,Length 18m
Puller block no 4,Net/Gross 20/22kg

